

W0930,W1230,W1530,W1830,W2130
 W0942,W1242,W1542,W1842,W2142

ASSEMBLY INSTUCTIONS

Getting started:

prepare a protection layer, a screwdriver

STEP 1: Joint side panel with back panel

STEP 2: Joint top panel with side panel

STEP 3: Joint bottom panel with side panel

STEP 4: Attach frame on





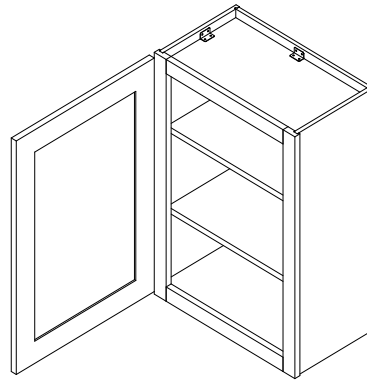

STEP 5: Put on the adjustable shelves

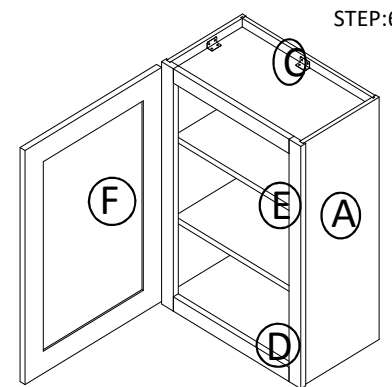
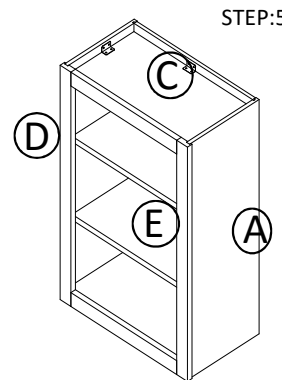
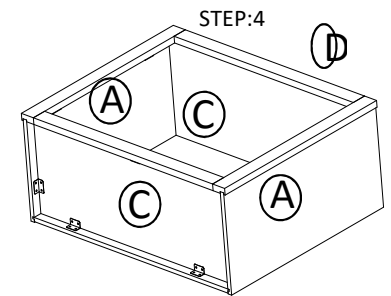
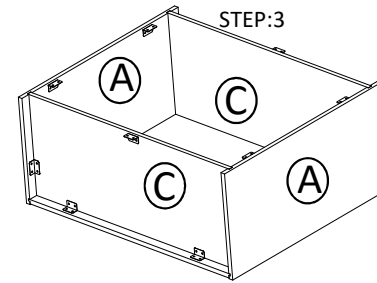
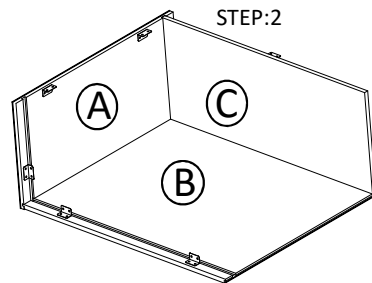
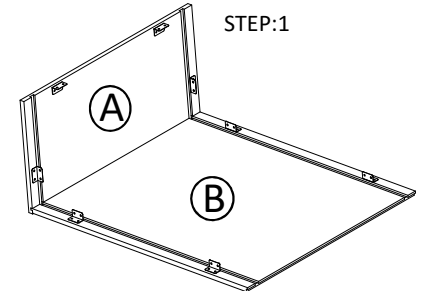
STEP 6: Fix door onto the frame and adjust the cover-space

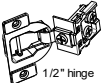

PARTS LIST		
NO.	Description	QTY
A	SIDE PANEL	2
B	BACK PANEL	1
C	TOP&BOTTOM PANEL	2
D	FACE FRAME	1
E	ADJUSTABLE SHELF	2 OR 3
F	CABINETS DOOR	1

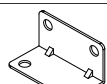

7	1/2" HINGE	2	
6	3/4" ROUND HEAD SCREW	2	
5	BUMPER	2	
4	SHELF CLIP	8	
3	9/16"ROUND HEAD SCREW	40	
2	CLEAT	10	
1	1"FLAT HEAD SCREW FOR CARCASS	4	
NO.	Description	QTY	PICTURE

HARDWARE LIST